

PAPER • OPEN ACCESS

FDS simulation of fire spreading on facade heat insulating system

To cite this article: Roman Yakovchuk *et al* 2021 *IOP Conf. Ser.: Earth Environ. Sci.* **635** 012009

View the [article online](#) for updates and enhancements.

FDS simulation of fire spreading on façade heat insulating system

Roman Yakovchuk*, **Andriy Kuzyk**, **Olexander Kagitin**, **Andriy Ivanusa** and **Sergiy Yemelyanenko**

Lviv State University of Life Safety, 35 Kleparivska Street, Lviv, Ukraine, 79007

Abstract. The main purpose of this work was to determine the parameters of the fire test of the exterior wall construction with facade heat insulation and plaster to spread the fire by FDS simulation, to reproduce the real conditions of fire test and to verify the developed model by comparing the obtained data with experimental results. Satisfactory error was obtained when measuring temperatures experimentally and by computer simulation during experiments.

An experimental study of the spread of fire on the surface of external walls with facade insulation and computer simulation of full-scale tests using computer methods of gas hydrodynamics. Using computer simulation of the parameters of the fire test of the facade insulation system for the spread of fire in the FDS environment, numerical and graphical indicators were obtained that characterize the process of occurrence, spread and development of fire by the surface of the facade insulation system. Computer modelling of fire dynamics using FDS numeric tool was implemented and results obtained were compared with experimental data in order to check possibility of use of appropriate software for the reproduction of real conditions of fires at residential buildings.

Keywords: computer modelling of fire, fire-resistance, external fire, Fire Dynamics Simulator, PyroSim, computational fluid dynamics model of fire

1. Introduction

The use of facade insulation systems not only improves the thermal performance of building envelopes, ensures their energy efficiency, improves the architectural appearance of buildings and structures, but also increases their fire hazard. For arrangement of external thermal insulation and decoration systems of facades use two basic technologies: 1 - facade thermal insulation composite system of external walls with thermal insulation with plaster equipment (plaster thermal insulation system); 2 - hinged insulation system with air layer (ventilated facades). When performing work on insulation of exterior walls, it is necessary to ensure compliance with the requirements [1] in the design and application of structures with front thermal insulation, as well as to observe the general rules of arrangement of structures and operation of buildings with systems of facade thermal insulation of exterior walls.

Exterior wall construction with facade thermal insulation is a system that includes a load-bearing part of the wall and a set of thermal insulation, designed to provide normative values of thermal performance of wall structures, protect buildings and structures from environmental influences, ensure the normative microclimate of buildings and structures and provide facades and structures of attractive aesthetic

* Corresponding author: yakovchukrs@ukr.net



appearance. The facade thermal insulation system works as a single complex in which each layer fulfills its specific functions.

As practice shows, quite often contractors do not follow or neglect the above rules and requirements, can use insulation materials that do not have the necessary technical documentation or are not certified in Ukraine [2]. Therefore, there are often instances of ignition of structures of facade thermal insulation systems due to non-compliance with fire safety rules during their installation, as well as during the operation of the finished facade system. Examples of fires with the spread of fire on the facade systems of buildings indicate their particular danger [3].

Therefore, the problems of ensuring fire safety of the external walls of houses with facade insulation with plaster, as well as the development of organizational and technical measures aimed at improving the fire safety of such facilities are becoming increasingly important.

Assessment and prediction of fire resistance of facade thermal insulation systems is performed on the basis of laboratory tests and a limited number of field tests, which makes it impossible to draw adequate conclusions about the reliability of such structures in real fire conditions. The limited amount of research in this area is explained by the complexity of the preparation of the experiment and the considerable material costs.

Recently, the use of special software Fire Dynamics Simulator (FDS) [4] for computer simulation of the results of tests of building structures for fire resistance is quite popular. This software allows you to perform numerical simulations of the temperature distribution of structures during fire tests [5], as well as other parameters that are important for predicting the probability of progressive collapse in case of fire damage [6].

The article presents the results of FDS simulation of the combustion of a facade thermal insulation system in a room fire using the FDS program, which was implemented by computational fluid dynamics (CFD) model of fire [7]. CFD method does not contain any simplifying assumptions about the structure of gas-dynamic streams in the computational space, and therefore it is fundamentally applicable to consider any scenario of fire development at an object of almost any geometric shape.

2. Analysis of the recent studies and publications

Using of facade insulation systems improves the thermal performance of building enclosures, provides energy efficiency, enhances the architectural appearance of buildings and structures, but increases the fire risk of such objects. Many researchers, both native and foreign, have been engaged in research of problems of fire safety of facade systems, including hinged ventilated ones.

Publications [8-15] rightly note the unresolved problems of fire safety of such buildings, the lag of fire regulations from modern architectural and design solutions.

In [8] G. Jensen reviews the European and American standards for testing ventilated facades for the propagation of fire, and compares perforated and continuous fire barriers based on the European standard ASTM E2912-17 [9].

The purpose of the work [10] was to develop a mathematical model of fire spreading in a three-story building during full-scale fire-response tests; research of accuracy and reliability of parameters of temperature modes of fire in separate premises of the building. The Pyrosim computer system, a user shell for the Fire Dynamics Simulator program, was used to calculate the temperature in the models of premises under fire. A numerical experiment was conducted to model full-scale tests of premises with fire in a three-story building using computer gas-hydrodynamics methods.

In paper [11] the works aimed at using the Fire Dynamics Simulator (FDS) software for computer simulation of fire propagation by the surface of facade systems and comparison of experimental and numerical data are analyzed. Computer simulation of fire dynamics was performed using the numerical tool FDS, and the obtained numerical results were compared with experimental data to test the possibility of using software to reproduce the real conditions of fire in residential buildings.

In [12, 13] investigates the unsolved problem of fire safety facade systems and fire regulations discrepancy and modern architectural designs.

[14] obtained the results of simulating the propagation of flames by the surface of insulating materials such as extruded polystyrene (XPS) and polyurethane. A heat dissipation rate was recorded for combustion intensity analysis, where flame height was recorded as a function of heat dissipation. The correlation between the height of the flame and the total heat flux is investigated.

In [15] Kumm M., Söderström J. and A. Lönnermark analyze the problems that firefighting services may encounter when extinguishing the fire of facades of buildings made from foamed EPS (EPS). The authors investigate the characteristics of the EPS and the results of fire tests conducted at the landfill. Threats are presented that can affect or completely limit the safe evacuation of people during the fire of the facade of a home.

In [16] the propagation of flame by the surface of heat-insulating extruded polystyrene (XPS) and polyurethane foam was studied. During the experiment, various phenomena of flame propagation were observed, and the heat release rate was used to analyze the combustion intensity of the studied samples. The flame height is presented as a function of heat release (HRR), as well as the relationship between the flame height and the total heat flux.

The main purpose of this work was to determine the parameter of the fire test exterior wall construction with facade heat insulation with plaster to spread the fire by FDS simulation, to reproduce properly the real conditions of fire tests and to verify the developed model by comparing the obtained data with experimental results.

3. Methods

Full-scale tests for fire spread were conducted on an external wall construction fit with façade heat insulation and finished with rendering using slabs fabricated from expanded polystyrene as heat insulating material.

The test were conducted as specified by [17]. Essence of the test method lied in the determination of the sizes of the damaged section of the façade heat insulating system and temperature rise inside the heat insulating and finishing system having been applied to a fragment of two-floor building (Figure 1) of 5.6 m total height at ground floor of which (fire chamber) temperature-time curve was being created close to standard temperature/time curve standardized by [18].

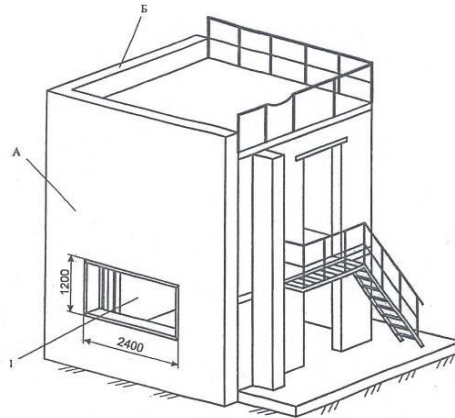

Figure 1. Fragment of a building for the testing of external wall constructions fit with façade heat insulation and finished with rendering and heat insulating material for fire spread [17]

“A” and “B” walls of the fragment (Fig. 1) were designated for the installation of the façade heat insulating system to be tested for fire spread. The façade heat insulation was applied upon “A” wall and upon a section of “B” wall (1.0 m from the edge of “A” wall) of the fragment of a two-floor building (Figure 2).



Figure 2. Appearance of a fragment of a building to be used for testing of external wall constructions fit with façade heat insulation and finished with rendering and heat insulating material for fire spread before commencement of the tests

Temperature of the medium nearby the external surface of the façade system was measured on “A” wall at twenty points using thermocouples. At that measuring junctions of the thermocouples were installed 20 mm to 30 mm from the surfaces of the walls bearing heat insulating systems. Layout of thermocouples T13 to T32 is shown on Figure 3. Measuring junctions of thermocouples T13 to T32 were installed 20 mm to 30 mm from the finishing layer of the façade heat insulation, but those of thermocouples T33 to T48 were installed within the layer of slabs fabricated from expanded polystyrene 25 mm from the surface of contacting of protective layer and expanded polystyrene slabs.

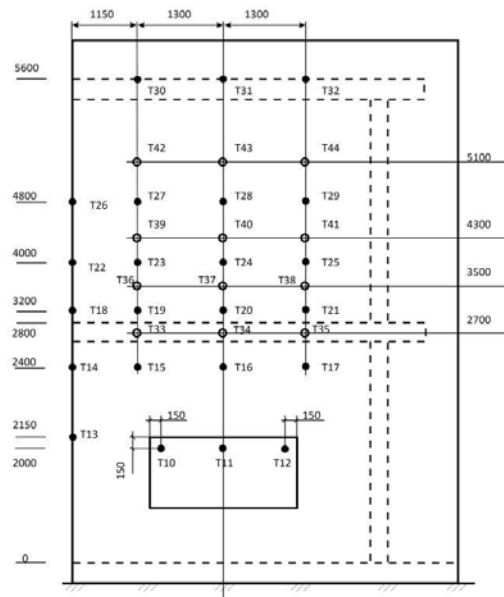

Figure 3. Layout of thermocouples on wall A: T10-T12 - thermocouples for measuring the temperature of the environment near the window opening; T13-32 - thermocouples for measuring the temperature of the environment near the outer surface of the facade system; T33-T44 - thermocouples for measuring the temperature inside the facade system [17]

The simulation was performed in FDS using the PyroSim graphical interface. FDS implements a computational hydrodynamic model (CFD) of heat and mass transfer during combustion. The FDS numerically solves the Navier-Stokes equations for low-speed temperature-dependent flows, paying particular attention to smoke propagation and heat transfer in a fire. The model is a system of partial derivatives, including the equation of conservation of mass, moment and energy, and is solved on a three-dimensional regular grid. Thermal radiation is calculated by the finite volume method on the same grid.

The FDS mathematical model is based on the use of partial differential equations describing the space-time distribution of the temperature and velocities of the gas environment in the room, the concentrations of the components of the gas environment (oxygen, combustion products, etc.), pressures, and densities. To model turbulence, FDS uses the Large Eddy Simulation (LES) method, a large-scale vortex simulation. LES is used to model dissipative processes (viscosity, thermal conductivity, diffusivity) whose scales are smaller than the size of a clearly defined numerical grid.

More details of the FDS mathematical model can be found in the technical manual [19]. FDS model has undergone extensive evaluation studies conducted by experts from the National Institute of Standards and Technology (NIST) and other organizations [20].

4. Results and discussion

Measuring and recording of the temperature inside the building fragment was conducted at intervals not exceeding 1 min. Supervision of the test specimen was conducted as well and chronological description of its changes was compiled specifying, in particular, deformations, crippling, flame occurrence, cracks, smoke, softening, melting, materials charring and so on.

Figure 4 shows photos of the building fragments during the full-scale test at various moments.

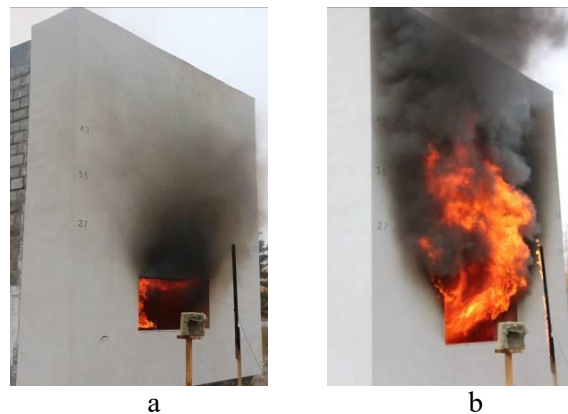

Figure 4. Appearance of the building fragment at the time of testing at the following moments from the commencement: a – 5 min.; b – 30 min.

Results of the research during the tests are given in Table 1.

Table 1. Results of the research during the tests

Time, min.	Results of the research
0	Ignition of the test fire.
6	Flame pulses and comes out of the window opening to the height of up to 2.7 m; commencement of crumbling of the external finishing layer of rendering at the window opening framing.
10	Flame pulses and comes out of the window opening to the height up to 2.7 m, and at some moments it reaches height of up to 3.5 m. Crumbling of the external finishing layer of rendering above the window opening framing within the flame impact area at a height of up to 2.7 m.
15	Flame pulses and comes out of the window opening to the height of up to 2.7 m, and at some moments it reaches height of up to 3.5 m. Crumbling of the gypsum plaster within the fire chamber and window opening.
20	Flame pulses and comes out of the window opening to the height of up to 3.5 m, and at some moments it reaches height of up to 4.3 m. Flashes of pyrolysis products up to 1 s duration within the flame impact area between the window opening frame and fire separation collar. Crumbling of the external finishing layer of rendering below the window opening within the flame impact area at a height of up to 3.5 m.
25	Flame pulses and comes out of the window opening to the height of up to 4.3 m. Crumbling of the external finishing material of rendering in the external finishing layer of rendering and formation of cracks in the external reinforcement and protective layer within the flame impact area at a height of up to 3.5 m. Crumbling of the external reinforcement and protective layer above the window opening within the flame impact area at height of up to 3.0 m.
31	Putting out of the rib in the fire chamber.

Figure 5 shows layout of the damages of the heat insulating material (slabs fabricated from expanded polystyrene) after the tests. There was no flame spread during the tests across external surface of the construction of façade heat insulation finished with rendering and heat insulating material based on slabs fabricated from expanded poly styrene beyond the boundaries of its direct contacting with flame generated in the fire chamber. Maximum temperature values inside the façade heat insulation

construction in the reference points (Fig. 3) at “A” wall were 359 °C (T34) at 2.7 m height, 227 °C (T37) at 3.5 m height, 198 °C (T40) at 4.3 m height and 96 °C (T43) at 5.1 m height.

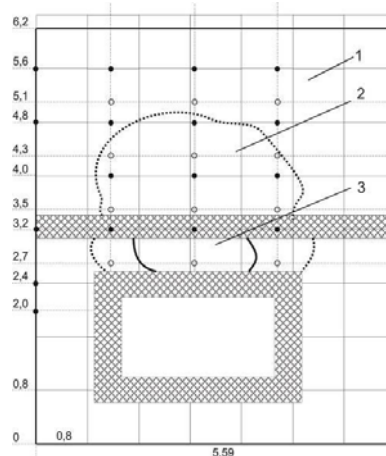

Figure 5. Layout of damaged heat insulating material fabricated of expanded poly styrene slabs of “PSB-S-25” type: 1 – area of non-damaged heat insulating material fabricated of expanded poly styrene slabs; 2 – area of partly damaged heat insulating material fabricated of expanded poly styrene slabs; 3 – area of completely damaged heat insulating material fabricated of expanded poly styrene slabs; ○ – thermocouples located completely within the façade heat insulation; ● – thermocouples located nearby the surface of the façade heat insulation

The total time of computer simulation to determine the parameters of the fire test of the facade insulation system for the spread of fire was 169 hours. The view of the calculation model for determining the parameters of the fire test of the structure of the outer wall with facade insulation with plaster for the spread of fire, made in PyroSim is shown in Fig. 6.

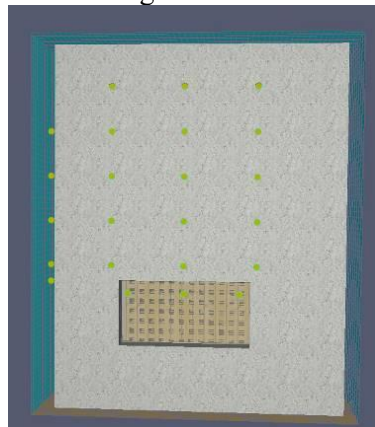

Figure 6. General view of the design model of the outer wall structure with facade insulation with plaster to spread the fire

It was determined as result of computer simulation that maximum heat output of fire is reached at approximately 1,200 s (20 minutes) point of time and it is equal to 4600 kW. Local temperature values corresponding to maximum heat output reach 660 °C to 960 °C. Average temperature value within the burning area (fire chamber) at 20th minute equals to 760 °C to 780 °C.

Appearance of the building fragment during computer simulation process at various moments of time is shown of Figure 7.

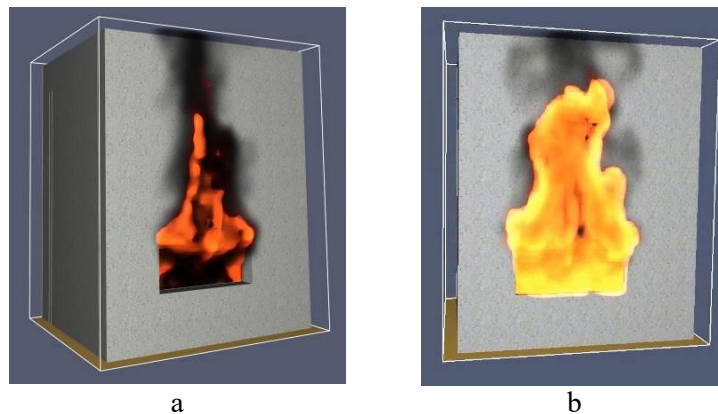
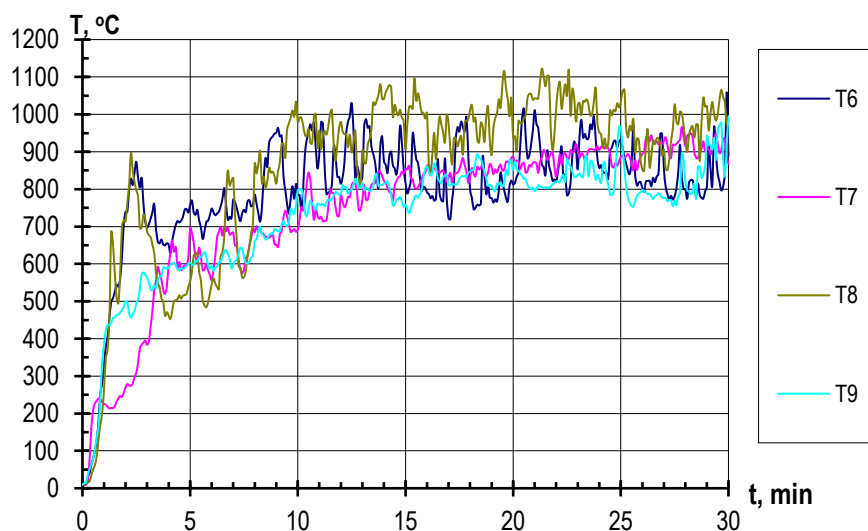

Figure 7. Appearance of the building fragment at the time of simulation at the following moments from the commencement: a – 5 min.; b – 30 min.

We fulfilled prognostication of dynamics of development and spread of dangerous factors of fire (smoke, heat, carbon monoxide etc.) using computer simulation; moreover, we derived numeric values and graphic representations of temperature of combustion products and heat release rate, temperature distribution within the fire chamber, inside the façade heat insulation system as well as at its surface, and heat release rate. The obtained results of computer modeling of the dynamics of development and spread of fire on the surface of the thermal insulation and finishing system correspond quite well to the results of foreign authors.

Results of FDS simulation are used for numeric evaluation of the temperature values within the fire chamber, inside and nearby the surface of the construction of the façade heat insulation and their comparison with the data derived empirically (Figures 8-10).



a

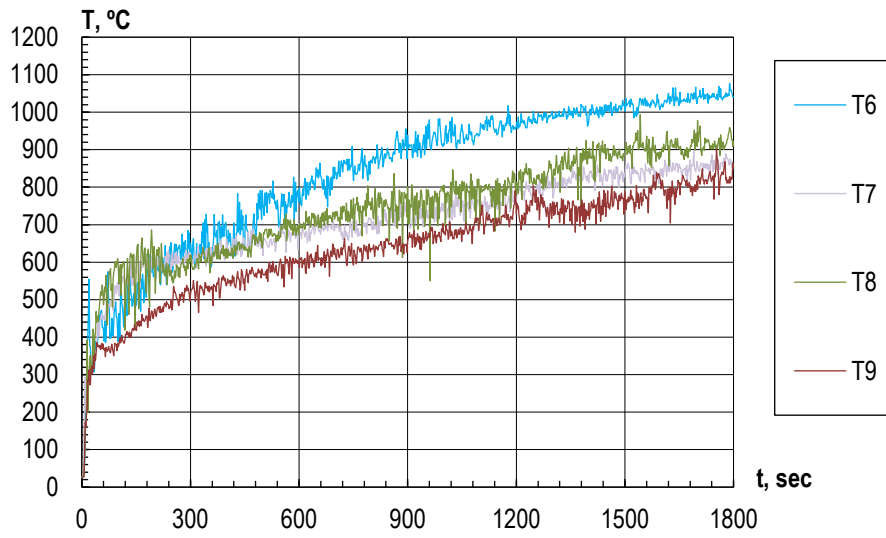

b

Figure 8. Temperature change in the fire chamber (thermocouples T6-T9): results of experiment (a), results of FDS modeling (b)

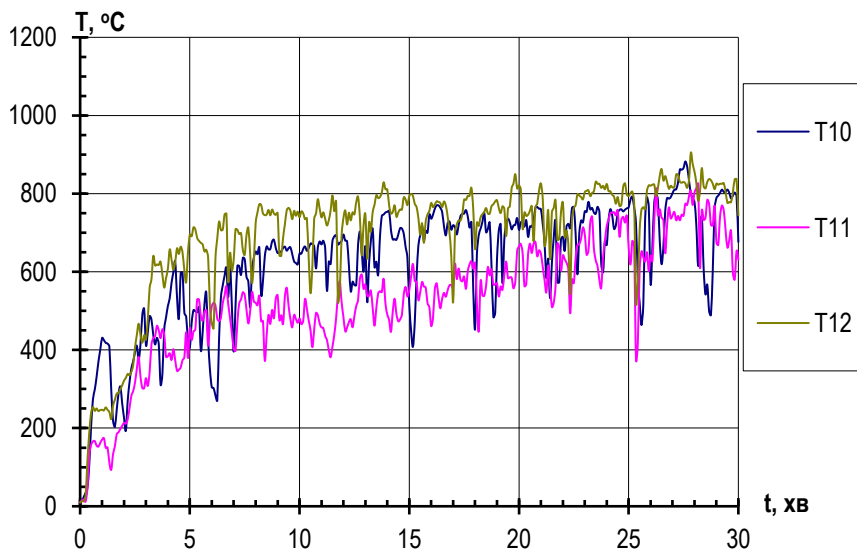

a

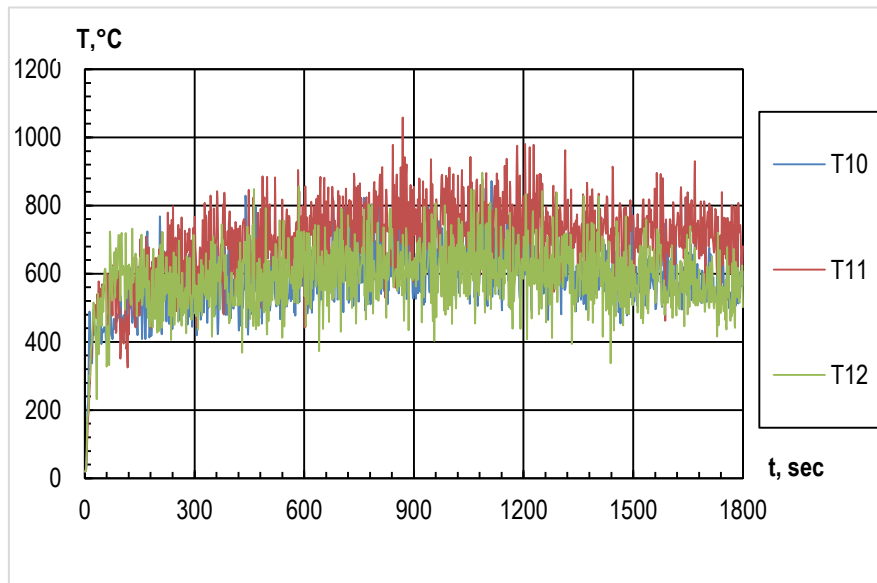

b

Figure 9. Temperature change in the window opening (thermocouples T10-T12): results of experiment (a), results of FDS modeling (b)

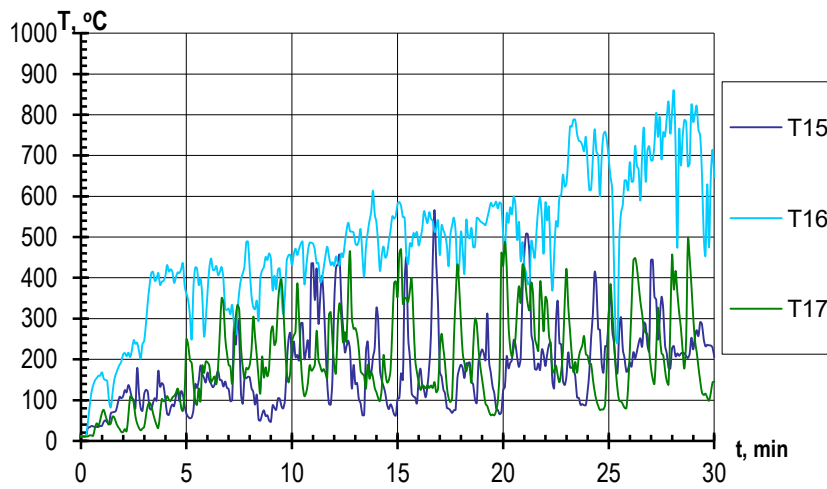

a

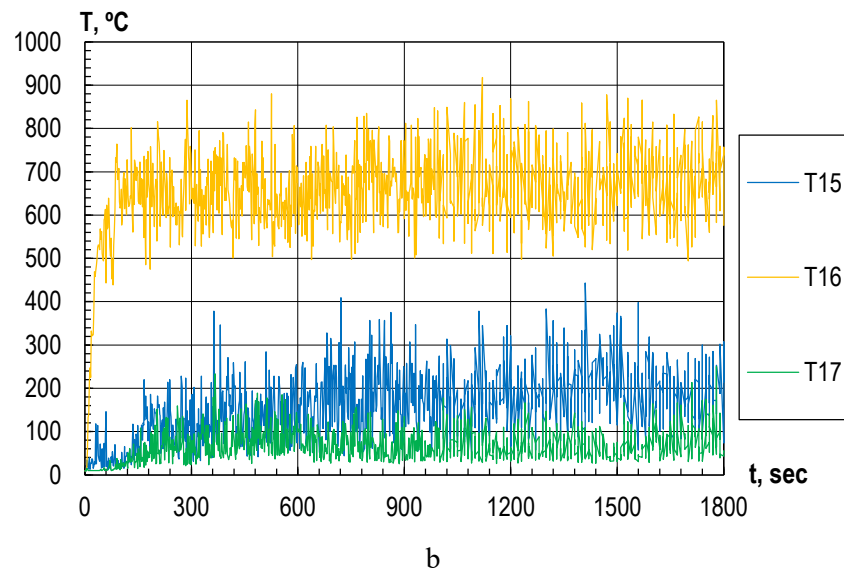

Figure 10. Temperature change near the surface of the facade insulation system (thermocouples T15-T17): results of experiment (a), results of FDS modeling (b)

Using computer simulation of the fire test parameters of the system of façade heat insulation for fire spread in FDS environment numeric and graphic performance were derived which characterize processes of occurrence, spread and development of fire across the surface of the system of façade heat insulation of a building. Simulation results derived allowed reproduction in due manner real conditions of testing, and when comparing experimental data and numeric calculations satisfactory results were obtained.

5. Conclusions

1. An experimental study of the spread of fire on the surface of external walls with facade insulation and computer simulation of full-scale tests using computer methods of gas hydrodynamics. Using computer simulation of the parameters of the fire test of the facade insulation system for the spread of fire in the FDS environment, numerical and graphical indicators were obtained that characterize the process of occurrence, spread and development of fire by the surface of the facade insulation system.
2. The numerical model was constructed in the CFD program Fire Dynamics Simulator (FDS) with analogous geometry and instrumentation. The general features of the fire test were well reproduced in the numerical model however temperatures close to the fire source could not be properly accounted for in the model. Simulation results derived allowed reproduction in due manner real conditions of testing, and when comparing experimental data and numeric calculations satisfactory results were obtained.
3. It was determined as result of computer simulation that maximum heat output of fire is reached at approximately 1,200 s (20 minutes) point of time and it is equal to 4600 kW. Local temperature values corresponding to maximum heat output reach 660 °C to 960 °C. Average temperature value within the burning area (fire chamber) at 20th minute equals to 760 °C to 780 °C.
4. The most dangerous area on the surface of the facade is above the flame torch and is directly affected by the external flame coming out of the window. General temperature values within the fire chamber derived experimentally and numerically were different by 12 % to 16 %, value of the temperature in the window opening was underestimated by 16 % to 24 %, and temperature nearby the surface of the heat insulating and finishing system within the model was both overestimated by 22 % (T16 and T20) and

underestimated by 18 % (T17, T21 and T19). Temperature values inside the façade heat insulating system did not exceed experimental data and deviation of average temperature values was equal to 16 %.

6. References

- [1] DBN V.2.6-33:2018 Constructions of heat insulated external walls. Requirements for the designing. (2018). Kiev: “Ukrarkhbudinform” (in Ukr.)
- [2] Kuzyliak, V., Yakovchuk, R., & Veselivskiy, R. (2016). Fire risk of thermal insulation materials using in building industry. *Fire Safety*, **28**, 81-87 (in Ukr.) <https://journal.ldubgd.edu.ua/index.php/PB/article/view/229>
- [3] Yakovchuk, R., Kuzyk, A., Miller, O., & Lyn, A. (2018). Heat insulation-apparatus systems of household facade as a factor of increased fire hazard. *Fire Safety*, **32**, 80-89 <https://doi.org/10.32447/20786662.32.2018.12>
- [4] McGrattan, K., et al. (2015). Fire Dynamics Simulator User’s Guide, FDS Version 6.2.0, SVN Repository Revision: 22352, NIST Special Publication 1019, National Institute of Standards and Technology, Gaithersburg, MD USA.
- [5] Yakovchuk, R., Kuzyk, A., Miller, O., & Lyn, A. (2018). Heat insulation-apparatus systems of household facade as a factor of increased fire hazard. *Fire Safety*, (32), 80-89. <https://doi.org/https://doi.org/10.32447/20786662.32.2018.12>
- [6] V. Dréan, R. Schillinger, G. Auguin “Fire exposed facades: Numerical modelling of the LEPIR2 testing facility” *MATEC Web of Conferences* 46 03001 (2016) DOI: 10.1051/mateconf/20164603001
- [7] Guan H. Y., Kwok K. Y. Computational Fluid Dynamics in Fire Engineering. *Theory, Modeling and Practice*, Butterworth-Heinemann, Elsevier Science and Technology, ISBN: 978-0-7506-8589-4, 2009. – 530 p.
- [8] Jensen, G. (2013). Fire spread modes and performance of fire stops in vented façade constructions – overview and standardization of test methods. *MATEC Web of Conferences*, 9, 02002, 1st International Seminar for Fire Safety of Facades. Paris, France, November 14–15, 2013. <https://doi.org/10.1051/mateconf/20130902002>
- [9] ASTM E2912-17 Standard Test Method for Fire Test of Non-Mechanical Fire Dampers Used in Vented Construction, ASTM International, West Conshohocken, PA, 2017, [doi: 10.1520/E2912-17](https://doi.org/10.1520/E2912-17).
- [10] Shnal T., Pozdieiev S., Yakovchuk R., Nekora O. (2020) Development of a Mathematical Model of Fire Spreading in a Three-Storey Building Under Full-Scale Fire-Response Tests. In: Blikharsky Z. (eds) Proceedings of EcoComfort 2020. EcoComfort 2020. *Lecture Notes in Civil Engineering*, vol 100. Springer, Cham. https://doi.org/10.1007/978-3-030-57340-9_51
- [11] Yakovchuk R., Kuzyk A., Skorobatko T., Yemelyanenko S., Borys O., Dobrostan O. (2020). Computer simulation of fire test parameters façade heat insulating system for fire spread in fire dynamics simulator (FDS). *News of the National Academy of Sciences of the Republic of Kazakhstan. Series of geology and technology sciences*. Volume 4, Number 442 (2020), pp. 35 – 44. <https://doi.org/10.32014/2020.2518-170X.82>
- [12] Khasanov I., Molchadsky I., Goltsov K. and Pestritsky A. (2006). Fire hazard of mounted facade systems. *Fire Safety*, № 5, 36-47 (in Rus.).
- [13] Meshalkin, E., Barapebychuk, V. (2006). Fire safety of facade systems. *Sroyprofil*, № 5(51), 90-93 (in Rus.).
- [14] Hou, Yanan & Cheng, Xudong & Liu, Shenyou & Liu, Changcheng & Zhang, Heping. (2015). Experimental Study on upward Flame Spread of Exterior Wall Thermal Insulation Materials. *Energy Procedia*. **66**. 161-164. <https://doi.org/10.1016/j.egypro.2015.02.085>

- [15] Kumm, M., Söderström, J. and A. Lönnermark. (2013). EPS insulated façade fires from a fire and rescue perspective, 1st International Seminar for Fire Safety of Facades, Paris (France). DOI: [10.1051/mateconf/20130905003](https://doi.org/10.1051/mateconf/20130905003)
- [16] Hou, Yanan & Cheng, Xudong & Liu, Shenyou & Liu, Changcheng & Zhang, Heping. (2015). Experimental Study on upward Flame Spread of Exterior Wall Thermal Insulation Materials. Energy Procedia. 66. 161-164. <https://doi.org/10.1016/j.egypro.2015.02.085>
- [17] Procedure of fire tests of heat insulating and finishing facade systems for the external walls of buildings and constructions for fire spread, developed by UkrFSRI of the MOE of Ukraine, 2010. (in Ukr.)
- [18] DSTU B V.1.1-4-98* (1998). Building constructions. Fire resistancer testing methods. General requirements (in Ukr.)
- [19] Fire Dynamics Simulator. Technical Reference Guide. Volume 1: Mathematical Model / NIST Special Publication 1018-1. Sixth Edition. - 2015.
- [20] Fire Dynamics Simulator. Technical Reference Guide. Volume 3: Validation / NIST Special Publication 1018-3. Sixth Edition.- 2015.

Prasad, K.R., Kraemer, R.H., Marsh, N., Nyden, M., Ohlemiller, T., Pitts, W., & Zammarano, M. (2009). NUMERICAL SIMULATION OF FIRE SPREAD ON POLYURETHANE FOAM SLABS | NIST. Fire and Materials.

V. Dréan, R. Schillinger, G. Auguin “Fire exposed facades: Numerical modelling of the LEPIR2 testing facility” MATEC Web of Conferences 46 03001 (2016) DOI: 10.1051/mateconf/20164603001